

Varenummer: 0109052
 Beskrivelse: Seeger låsering AS 35X2.5
 Fjederstål
 Note: Monteres med ZGA tang

Mål

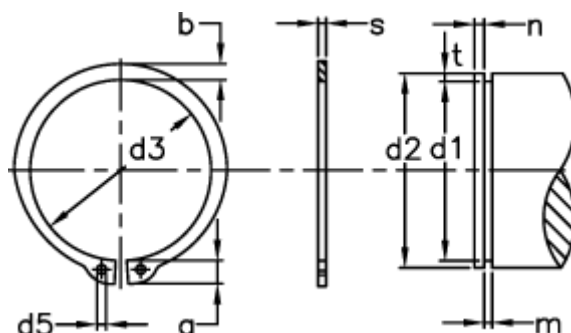

a max	= 6.7	d5 min	= 2.5	s	= 2.50
AN mm ²	= 107.0	FN kN	= 17.80	t	= 1.00
B	= 2.78	FRg kN	= 15.4	Tang	= ZGA-3
b	= 4.2	FR kN	= 86.0	tol	= -0.07
Betegnelse	= AS 35	g	= 1.5	tol	= +0,25 -0,50
d1	= 33.0	m min	= 2.65	tol	= -0.25
d2	= 35	n abl x 1000	= 17	vægt kg/1000	= 7.10
d3	= 32.2	Nominel træk	= 3.0		